



**OF connector Inspection,
Cleaning & Testing
General Guidelines**

Nexans Cabling Solutions

OF connector Inspection, Cleaning & Testing General Guidelines

1. Introduction

The cleaning of optical fibre connectors prior to the installation patch cords etc is not a new requirement but it has become a critical factor that now needs to be applied at all times. Latest applications have stringent link loss requirements and in order to ensure that the required performances levels are achieved during commissioning and operation, the cleanliness of all fibre interfaces needs to be always maintained.

Note: An IEC standard is addressing OF connectors cleaning:

*IEC 62627-01: Fibre optic interconnecting devices and passive components
– Fibre optic connector cleaning methods*

The current Nexans document is compliant with the IEC 62627-01 standard.

MPO connectors are most sensitive to contamination and require to be totally free of contamination in order to provide the expected loss performances.

To obtain accurate field tested values, errors free testing needs to be performed:

Several conditions have to be fulfilled to reach those tight figures:

- **good condition and clean test cords**
- **clean link connectors and adaptors**
- **respect of the manufacturer testing procedure**
- **correct use and calibration of the testing tool**

Even If only one the above conditions is not fulfilled, the measurement error can result in failed test result being obtained.

A few tenths of dB can make the difference between a pass and a fail.

The quality of the fibre connections is critical to obtain accurate measurements and good performance.

All pigtails and cords including MPO connectors (MPO cassettes and MPO trunks) shall be inspected and cleaned if necessary before the first mating.

An experienced and trained operator equipped with the right inspection, cleaning and testing tools (including good test cords) is required to avoid measurement errors at the commissioning stage.

2. Health and Safety requirements

It is extremely important that all technicians working with fibre optic technology are trained and take proper health and safety precautions.

Working with optical equipment without taking proper health and safety precautions may result in personnel injury or damage to the equipment.

Optical LASER transmission signals can be very dangerous to eyes and can cause significant injury if high power levels are present.

Before looking into a fibre

- Always ensure that the system lasers are 'Off'
- If the above can't be confirmed, first check the connector with a power meter
- Always use filtered inspection microscope / magnifiers to inspect fibre connectors

Note

The above are basic safety requirements – your company, regional location or particular installation requirements may specify additional requirements.

3. Inspection and cleaning

A well polished and perfectly cleaned connector Interface is of paramount importance to achieve correct fibre connections.

Dirt is the main cause of performance issues in optical networking and the consequences if not removed are high insertion loss and significant back reflection (Low return loss) affecting the signal transmission.

Particles that are present between two mated fibre connectors will not only dramatically increase the insertion loss but they can also permanently damage the polished end-faces of the fibre connectors as they are pressed against each other when first mated.

Note

Dirt present on one of the connectors will also be transferred to the other one as well as the coupler.

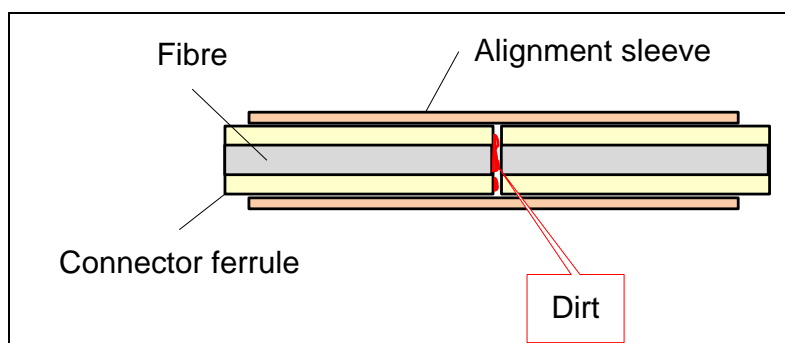

Fig.2: Typical Contamination

For instance if your testing cord connector is dirty, it may transfer contamination to the connectors of the link-under-test.

The contamination could also possibly damage the connectors affecting all the test results.

Visual inspection is the only way to determine if the fibre connectors are perfectly clean before mating them.

Always inspect (perform a visual inspection) and clean both connectors (if needed) before mating the two together.

All new pigtails, cords & MPO connectors shall be inspected before first mating.

All test set connectors, adapters, fibre test cords or jumpers that could cause contamination, must be inspected and cleaned (if required) before you proceed.

When cleaning fibre components, procedures must be followed precisely and carefully with the goal of eliminating any dust or contamination.

Inspection & Cleaning process

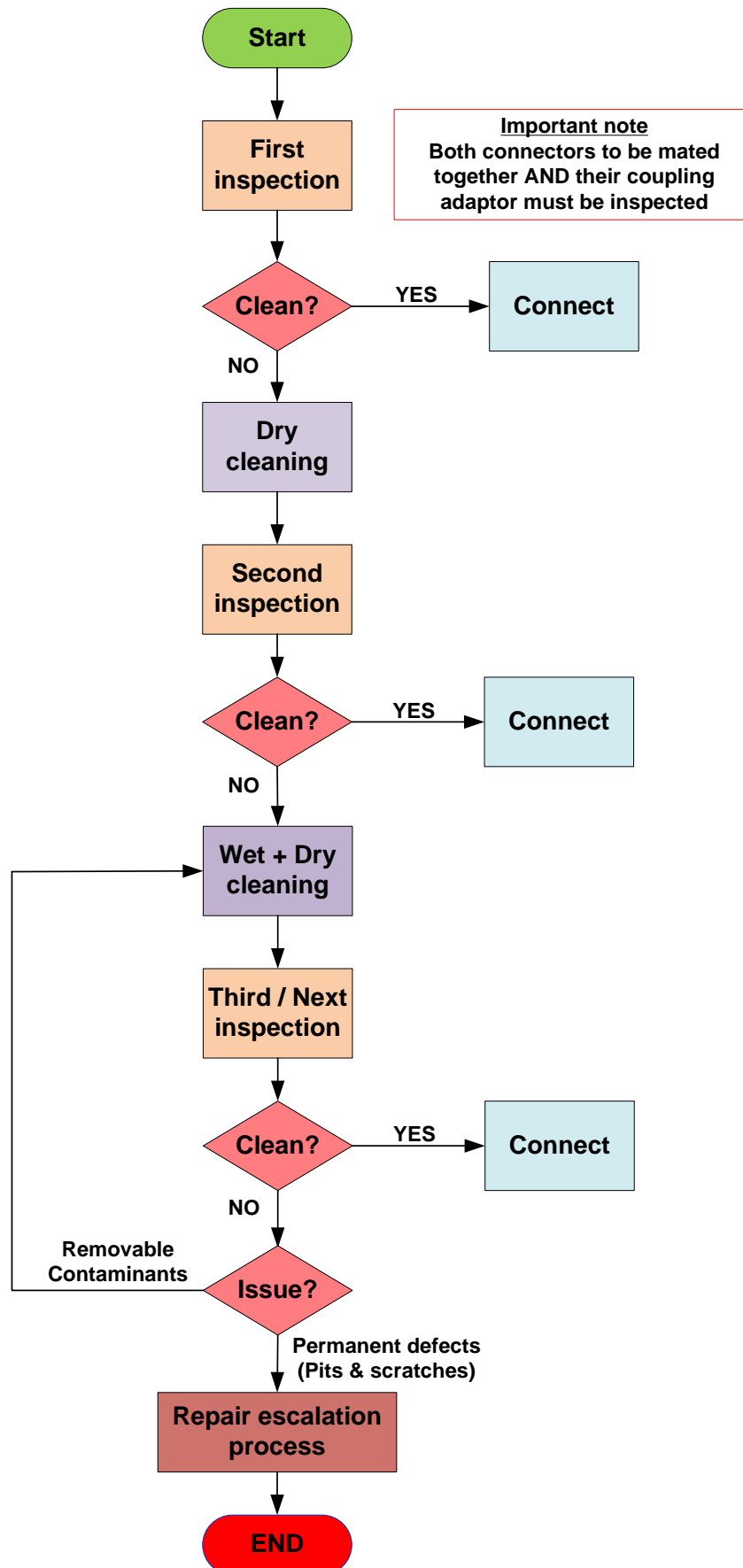

4. Inspection procedure

Connector ferrules shall always be protected by a protective cap when not in use. The cap will protect the end of the connector's ferrule from impact that can damage the polished surface.

However, it doesn't guarantee the cleanliness of the fibre end face even on new product.

Ideally unused protective caps should be stored in a sealed container to prevent contamination.

➔ The fibre end faces shall **always** be inspected prior to any testing, mating or re-mating.

A fibre inspection microscope (Fiberscope) shall be used to evaluate the cleanliness of the fibre end face.

There are two main categories of fiberscope:



Handheld fiberscope



Video fiberscope

Video fibre scopes provide a better view of the fibres; images can be displayed on external video screen and then captured and saved on file. They are also more flexible as different test heads are available for inspection of various types of connectors (MPO included) and for inspection of connectors directly inside patch panels' adaptors.

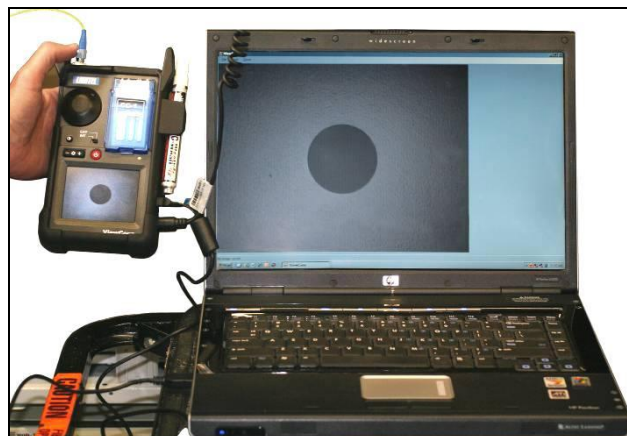

The proper magnification for viewing connectors is recommended to be 200x for multimode fibres and 400x for singlemode fibres.

MPO connector inspection requires the use of a specific test head to allow the fibre cores to be inspected one by one.

Connector end faces must be smooth, scratch-free and must not display cracks. Fibre inspection microscopes will give you a clear picture of any problems.

Grading Process

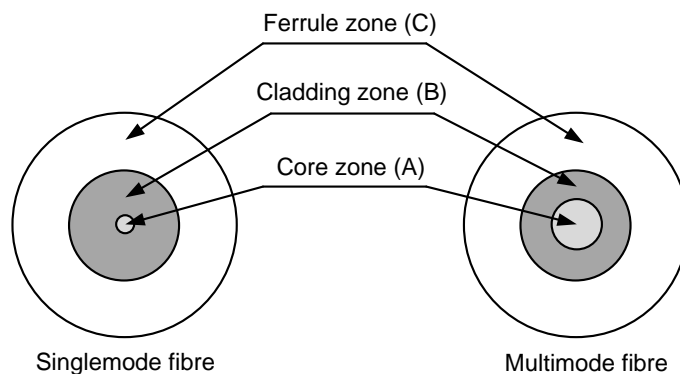

SC, LC or ST connectors

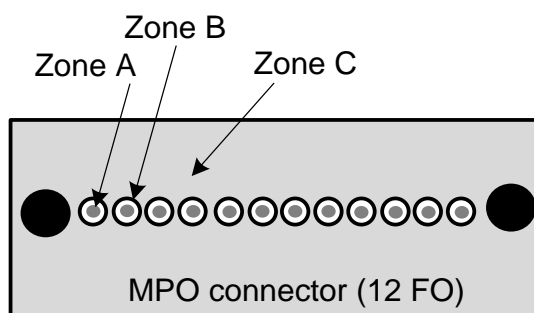

MPO connectors

Grading the fibre end face is performed with the aid of a fiberscope and allows you to:

- Identify the location of each zone (core, cladding, and ferrule) on the fibre end face.
- Look for any contaminant or scratch and in which zone is it located.
- Analyze the damage to define if the connector has to be replaced.

The core zone (A) where the light travels is the most critical one.

➔ **The zone A shall be completely free of any contaminant and damage since they will generate high losses and affect the connector performances.**

The Cladding zone (B) is the outer part of the fibre that reflects the light to maintain it into the core.

➔ **The zone B shall be free of any contaminant. Scratches or other permanent damage, if present, are only acceptable if located on the interface with zone C. Scratches or other permanent damages located near zone A are not acceptable.**

The Ferrule zone (C) is the surface of the tip of the connector in which the fibre is maintained.

➔ **The zone C shall be free of any contaminant.**

Contaminants and permanent damages

Dust, alcohol, finger grease or mineral oil, plastic or metallic particles are loose contaminants and can be removed using the proper cleaning procedure. A dirty connector shall be cleaned and re-inspected.

All three zones A, B and C shall be free of any contaminant as it can generate high losses and if the dirty connector is mated, it can cross-contaminate other connectors and/or couplers which could permanently damage both end faces of the fibres.

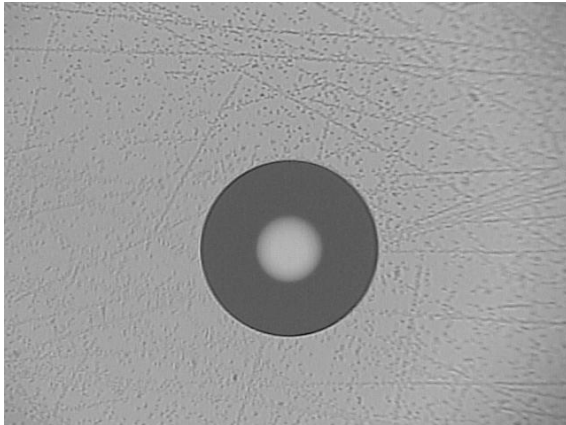

Perfect Multimode fibre

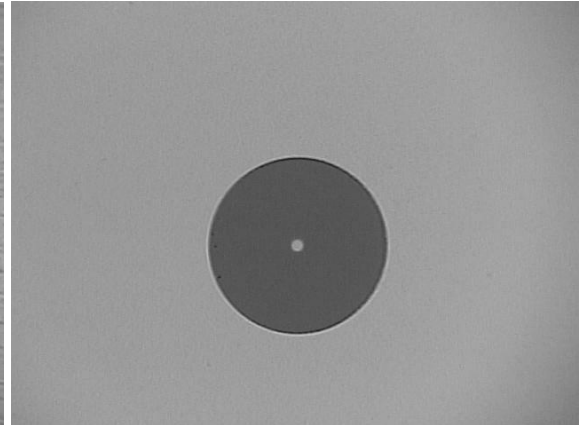

Perfect Singlemode fibre

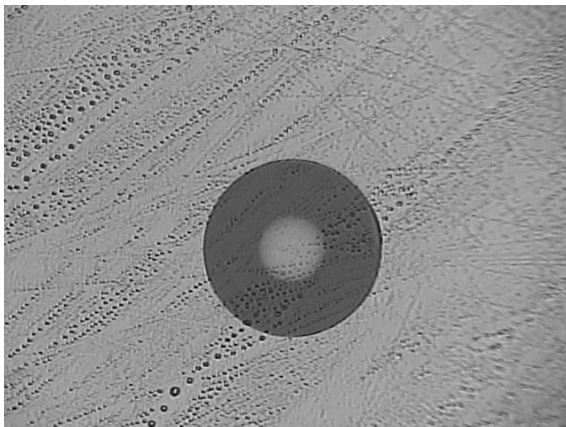

Alcohol residue contamination

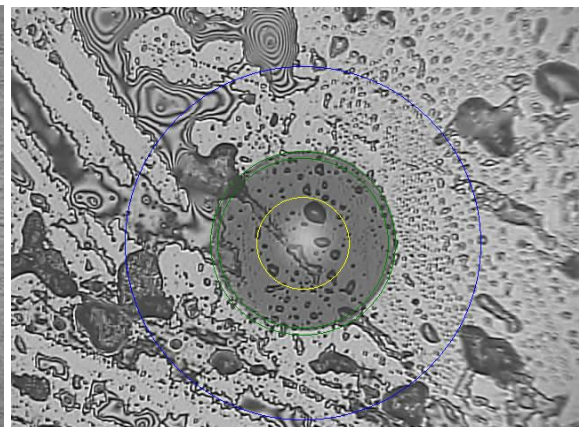

Liquid contamination

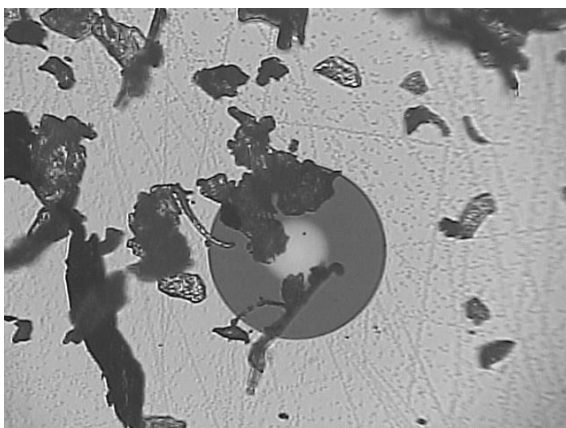

Dust contamination

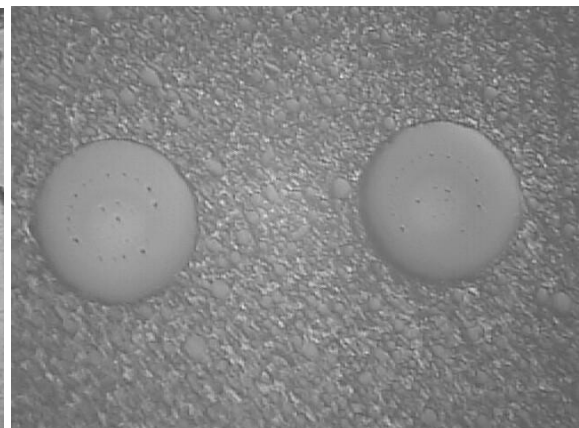

**Dust ring from mating contamination
on MPO connector**



Dust contamination (MPO connector)

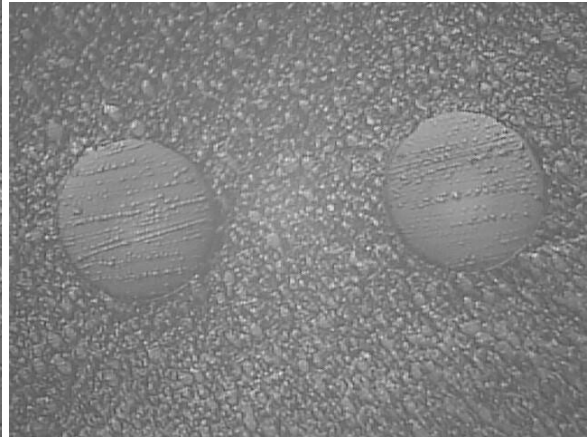

Alcohol residue (MPO connector)

Scratches, cracks, pits or fixed contamination such as embedded particles resulting from the mating of dirty connectors are regarded as permanent damage. Cleaning will not remove permanent damage. The connector need to be replaced.

The zone A shall be free of any permanent damage.

On the zone B permanent damage located near the core (Zone A) are unacceptable.

If they are located in zone B but adjacent to the zone C, they can be acceptable so long their number and severity are limited.

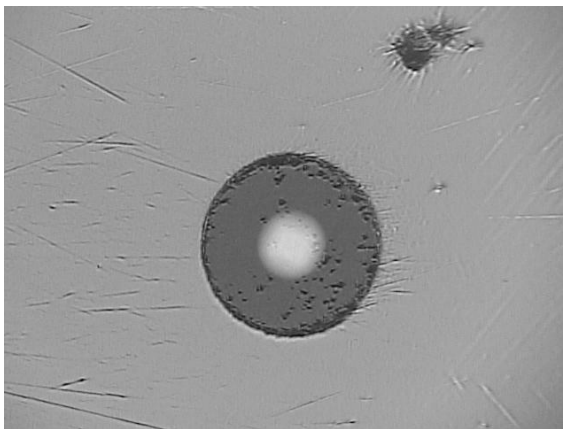

Pits on core + cladding

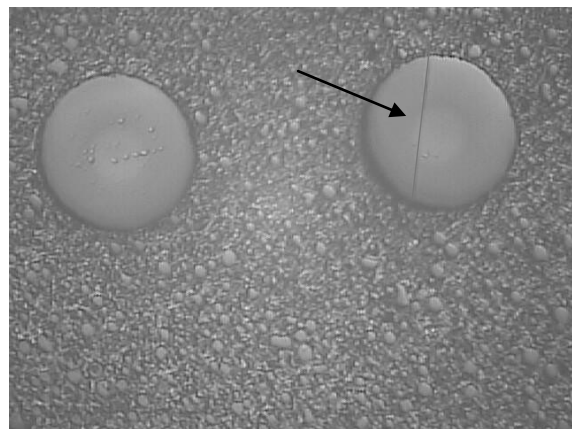

Scratch on core + cladding

Permanent defects

Additional recommendations

Testing equipment ports are frequently mated and are highly susceptible to become contaminated. Those contaminated ports will cross-contaminate the connectors of any patch lead that are mated with it.

Inspecting and cleaning of the test ports and leads before testing network connectors prevents cross-contamination.

5. Cleaning procedure

Connectors shall always be inspected first as it can reveal that the connector doesn't need cleaning. (Refer to inspection and cleaning process on page 4)

If a connector when removed from a coupler (adaptor) is dirty, it indicates that the mating connector is also contaminated. As a consequence, both connectors and the coupler must be cleaned and re-inspected before re-mating the connectors together.

Cleaning of the coupler is to be performed using lint-free swab.

5.1. Dry cleaning

If cleaning is required, dry cleaning methods are to be used first due to possibilities of residue when using alcohol based products.

Dry cleaning is an efficient method to remove dusts and finger grease but is not always sufficient to completely remove all contaminants.

The next chapter is dedicated to the cleaning recommendations of MPO connectors.

Lint-free wipes have to be used to dry clean accessible connectors.

Cleaning cassettes specifically designed for OF connector cleaning are also available on the market.

Dry Cleaning recommendations

- Using lint free wipe gently wipe the ferrule tip in the central portion of the wipe with a motion from top to bottom - do not re-use the same part of the wipe.
- Hold the end face of the connector at 90° perpendicular to the wipe (tilt the connector end face to the right angled for angled polished (APC) connectors)
- For MPO connectors the use of specific cleaning tools is required – Refer to next chapter

Be careful not to contaminate the cleaning area of the wipe with your hands. Do not place the wipe on a dirty surface.

Do not reuse wipes or at least the same area of the wipe to avoid cross-contamination or scratches (caused by the contaminated wipe) being introduced.

Cleaning tools are delivered with a removable guide cap in order to clean both accessible and non-accessible (that can't be removed from the adaptor) connectors end-faces.

Several versions of those tools are available

- for LC & MU connectors (1.25mm tip),
- for SC, FC & ST connectors (2.5mm tip)
- for MPO/MTP (MPO tip)

Make sure when using any cleaning tools that you follow the instructions provided with the tool.

The cleaning of connectors and of equipment OF ports can be performed using lint-free swabs, compressed gas dusters or specialised tools such as the LANmark-OF cleaners mentioned further in this document.

For cleaning connectors or adapters permanently affixed to the equipment please consult the manufacturers' specifications to minimize or eliminate the risk of damaging the equipment.



**LANmark-OF
Lint-free dispenser
P/N: N102.226**



**LANmark-OF
cleaning tool SC-FC-ST
P/N: N890.121**

Specialised tools can also be used. LANmark-OF smart cleaners can be used to clean unmated connectors or clean it inside the patch panel adaptor removing the guide cap from the nozzle.



**LANmark-OF cleaning tools
LC-MU version
P/N: N890.122**



**MPO version
P/N: N890.120**



Optical grade dust remover



Lint free swab

Tip

When using swap, gently press against the end-face and turn clockwise. Never reverse the motion. Continue to turn clockwise while slowly pulling the swap out of the adaptor.

5.2. Wet + Dry cleaning

If the second inspection reveals that the connector is still contaminated after the first cleaning (Dry only) a second cleaning (Wet + Dry) is required to clean the connector. This will define if the defects are loose or permanent.

As soon as permanent damage is detected, the connector has to be replaced.

The Wet + Dry method requires two steps:

1. Clean the side and the tip of the ferrule using a lightly moistened wipe/swab
2. Dry any remaining residue using a dry wipe/swab

Dry wipes and swabs can be used together with alcohol or specialised solvent. Do not over-saturate the wipe /swab.

Isopropyl alcohol (IPA) is the most widely known chemical used to clean fibres, however

- A container of IPA left open to the air can easily become diluted and contaminated.
- Contaminated IPA can lead to a residue being left behind on the end-face.

Note – OF cleaning fluid

New specialised chemicals have been developed. They are offering

- *Better evaporation rate*
- *Better ability to dissolve contaminants*
- *Non-flammable and non-hazardous (can be shipped, even by air, without hassles)*

Nexans recommend the use of specialised OF cleaning fluid.

The solvent must be compatible with the cleaning swab or wipe construction materials.



Sticklers™ Fibre Optic Splice & Connector Cleaner & wipes

If the connector is still contaminated after this Wet + Dry cleaning, you can try to redo it once more but you will most probably need to replace the connector as the remaining damage / dirt can then be considered as permanent damage.

5.3. MPO connector cleaning recommendations

For MPO connectors the use of specific cleaning tools is required.

Example: LANmark-OF smart cleaner – MPO version (Refer to former page).

But it may be possible that you will not get the expected result because the extreme sides of the MPO connector end face can't be reached by the tool due to the presence of the alignment pins.

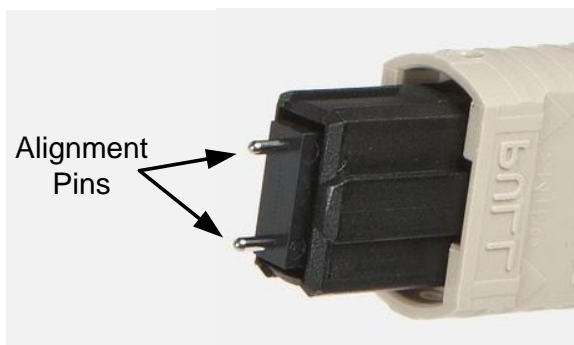
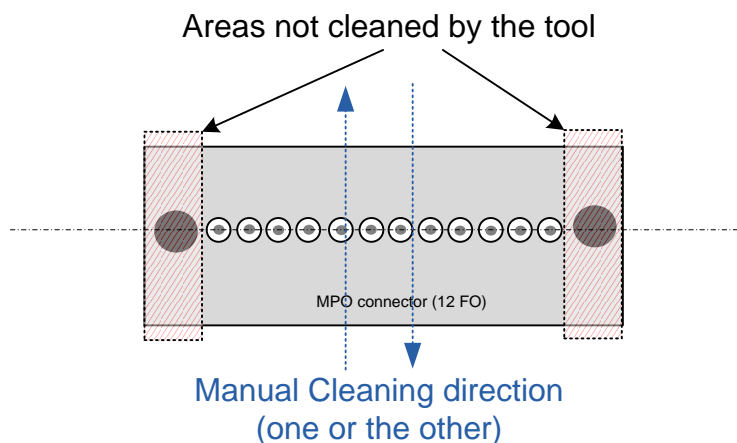

Pinned MPO connector



Unpinned MPO connector

Contaminants can be pushed on the side by the tool. In this case the dirt present on the red hatched areas will prevent the mated connectors to have a close contact and the performances will be affected.

If the manual cleaning of an unpinned and accessible connector is required:

- Use a lint free wipe or a MPO cassette cleaning tool onto the complete end face including the red areas.
- The cleaning has to be performed perpendicularly to the fibre row but never from side to side to avoid the contaminants to be rubbed over all the fibres and so cause permanent damages.
- Also, never reverse the direction of cleaning to avoid bringing back the wiped contaminants.



MPO cassette cleaning tools are designed to also clean pinned MPO

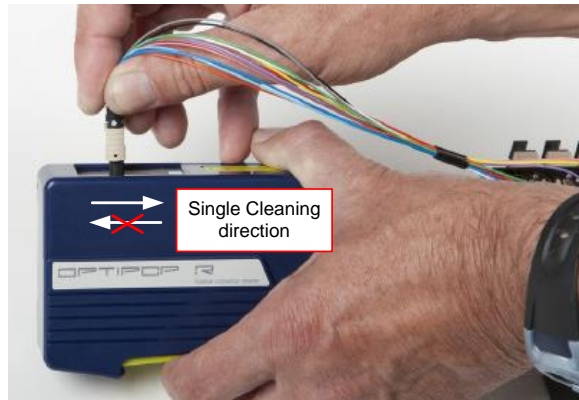

**Clean perpendicularly to the fibres
Do not reverse cleaning direction**

If the connector is pinned and/or inside a coupler (MPO cassette for instance)

- First try to blow the contaminants out of the coupler using a compressed gas/air duster.
Tip: first spray away from the connector to ensure that no liquid gas will be blown onto the connector as it can cause liquid contamination – Don't shake the duster.
- Should you need to remove the connector from the coupler to clean it, directly use the Wet + Dry method
- MPO cassette cleaning tools are designed to permit cleaning of pinned MPO
- Respect the cleaning recommendations listed for unpinned MPO cleaning
- The alignment pins can be cleaned using a 2.5mm swab (Wet + dry) – If so, the holes of the mated connector have to be cleaned as well
- To clean the alignment holes, use a small brush (Diameter: 2mm)
Tip: Some inter-dental brushes have the right dimensions

Example of brush
Central wire: $\varnothing=0,4\text{mm}$
Brush : $\varnothing=1,9\text{mm}$



MPO/MTP cleaning tool / N890.120 – Instruction sheet



1a. Accessible connector Dry cleaning



Step 4: inspect the connector – If dirty, repeat dry cleaning or proceed to Wet + Dry cleaning

1b. Accessible connector Wet + Dry cleaning

First apply alcohol or cleaning solvent onto a clean wipe and wipe the end of the MPO onto the wet area of the wipe. Then go to step 1 here above (1a).

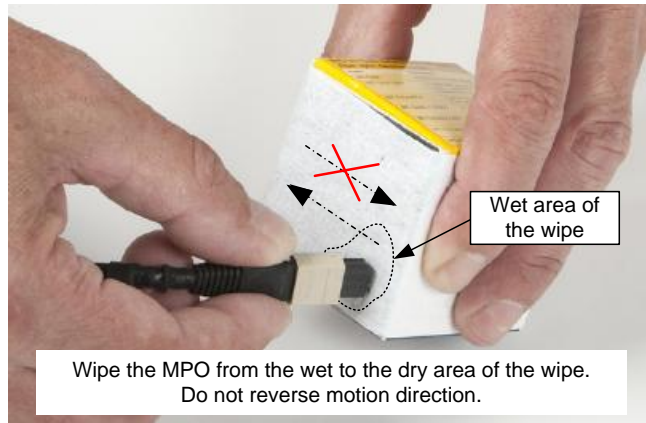

2a. Non directly accessible connector Dry cleaning

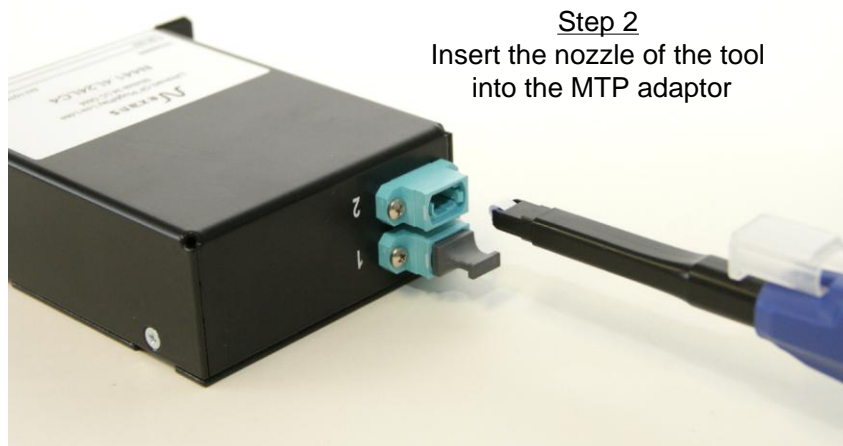

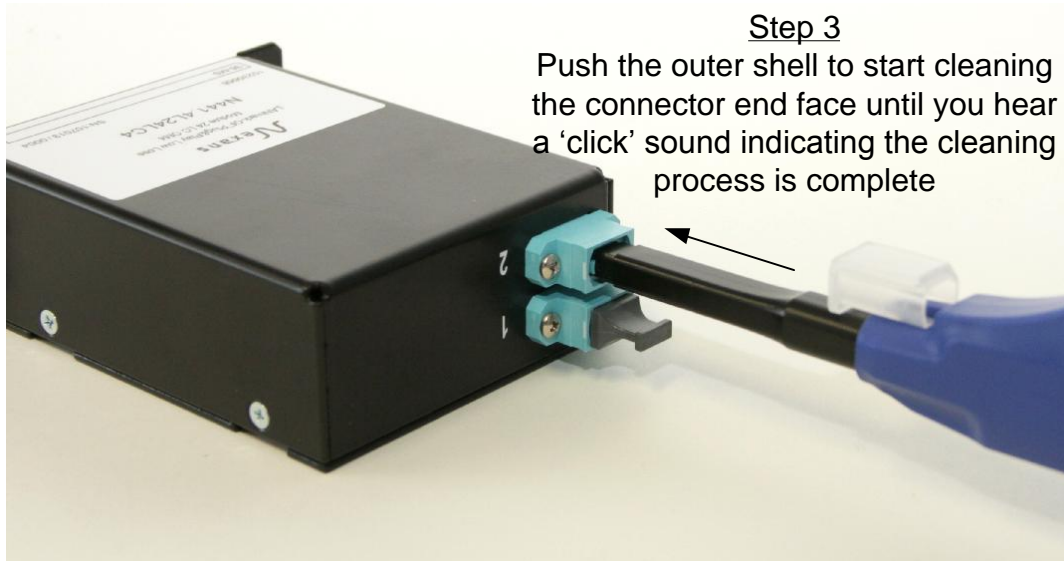

Step 4: inspect the connector – If dirty, repeat dry cleaning or proceed to Wet + Dry cleaning

2b. Non directly accessible connector Wet + Dry cleaning

First apply alcohol or cleaning solvent onto a clean wipe and damp the cleaning tool onto the wet area of the wipe. Then go to step 1 here above (2a).



6. Testing procedure

When you are very sure of the cleanliness of all links, testing connectors and adaptors it is now necessary to correctly set your tester and perform the testing according to the appropriate compliant procedure.

The NCS OF field testing procedure can be downloaded from our web site:

[Test procedures section of our library](#)

Contamination can occur during testing → regularly re-inspect test lead connectors.

If the testing connector is contaminated the last tested links should also be re-inspected for cross-contamination and re-tested if needed.

Important issues

1. Set the parameters of your tester

- Use the correct loss test limits
 - As per ISO/IEC 14763-3 edition 1 when using test cords terminated with reference grade connectors

These cords are supplied by the tester manufacturer

- As per ISO/IEC 11801 when using standard grade test cords

Nexans mandate to use only LANmark cords (N123.xxxxx) as standard grade test cords

- Set the Index of Refraction of the fibre under test
- Set the number of connectors and splices
- Set the length of the fibre under test if your tester is not able to do it automatically

2. Testing

- Use the correct procedure (Same or different connectors on tester and on the link)
- Use Encircled Flux (EF) compatible test heads and/or accessory or alternatively mandrels
- Perform the following steps to set your reference measurement
 - Connect your additional (s)
 - Connect your additional test lead
- Perform and record a first testing with your reference cords only using a singlemode (Blue) adaptor:

The result should be

- < 0.15 dB when using MM reference grade cords
- < 0.3 dB when using SM reference grade cords
- < 0.5 dB when using standard grade (Nexans) test cords (MM or SM)
- Test your links – never disconnect the launch cord from the source
- At the very minimum, set your reference before the start of each work session during the day and when the tester is switched on or recovers from sleep mode.
- Any result deviating from the average shall be investigated: connectors inspection + new reference measurement
- Replace all connectors showing permanent damage
- Regularly replace testing cords

Testing of MTP links terminated with MTP/LC cassettes

An FO link built using MPO cassettes is always terminated on LC or SC connectors. As a consequence, testing of those MPO links have to be performed in the same way as any other FO link.

MPO link includes two more connections (the two MPO connections on the rear side of the cassettes).

However Nexans **MTP** (See note) cassettes are warranted to have a low loss (< 0.6 db for MM). The maximum loss of a Nexans MM MTP Cassette is always below 0.75 dB.

When testing MTP Nexans OF links

A specific rule has to be applied: the total loss of one cassette has to be lower than

- 0.75 dB for Multimode (MM) fibres
- 1.05 dB for Singlemode (SM) fibres

These limits are valid

- for the whole cassette (MTP connector + LC or SC connector)
- for testing performed with both Nexans and reference test cords

When testing MTP Nexans OF links terminated with MTP/LC cassettes

- always set the tester to test against ISO 11801 limits whatever the type of cord selected to measure (Nexans or reference grade test cords)
- Set the number of connectors to 2 and the number of splices to 0 for MM fibres
 - ➔ This will set the loss limit to 1.5 dB (2x 0.75) + the loss of the fibre
- Set the number of connectors to 2 and the number of splices to 2 for SM fibres
 - ➔ This will set the loss limit to 2.1 dB (2x 0.75 + 2x 0.3) + the loss of the fibre

Testing of MTP trunks

There are various ways of testing OF links terminated on MTP connectors.

At least a couple of devices (from Psiber and Fluke Networks) equipped with MPO connectors are available to perform loss measurement of MPO/MTP trunks.

However, it is also possible to test these trunks using standard LSPM testers.

The various procedures are described in the Nexans OF field testing procedure.

The NCS OF field testing procedure can be downloaded from our web site:

[Test procedures section of our library](#)

Note

MTP is a registered trademark of US Conec and therefore identifies a specific brand of the MPO-style connector.

The MTP connector is a high performance MPO connector engineered for better mechanical and optical performance.

The whole range of MPO Nexans products is equipped with MTP connectors to provide enhanced performances.

7. Summary

Dirt is everywhere: Airborne, FO adapter, hands, clothing etc, and possibly even in protective caps.

- A single piece of dust can dramatically deteriorate the performance of a link.
- Mating a dirty connector can cause permanent damages to the two mated connectors.
- A dirty test cord can cross-contaminate and even permanently damage all tested connectors
- Even a brand new connector needs to be inspected.
- Inspecting fibre connector end-faces with a fiberscope (and then cleaned if necessary) is the only way to ensure that the performances of the FO connector mating are not affected by contamination.
- A single failure during the inspection, cleaning and testing processes can lead to networking failures or to faulty and/or failed testing results

→ Always inspect all FO connectors and clean them if dirty prior to any mating.

→ New pigtails, cords and other MPO cassettes and trunks have to be inspected just before their first mating on site.

→ Inspection and cleaning need to be performed accurately following the process described in the chapter 3

→ We strongly recommend our partners to acquire professional inspection and cleaning material and train their technicians accordingly

→ Maintenance and yearly calibration of the testing equipment is mandatory

8. Recommended materials

- Handheld or video Fiberscope – magnification: 200x/400x (MM/SM) - Video fiberscope is preferred
- Fiberscope optional accessories for both direct and through adaptor inspection
- Optional MPO fiberscope specific heads if using this connector
- Lint free wipes → *LANmark-OF Lint free dispenser: N102.226*
- Lint free swaps
- FO cleaning solvent (recommended) or Isopropyl alcohol >91%
→ Cleaner / Wipes / Swaps: *Sticklers™ Cleaning Products*
<http://www.sticklerscleaners.com>
- Optical grade dust remover
→ <http://www.sticklerscleaners.com/products/>
- Connectors cleaning tools – LANmark-OF cleaning tools
 - LANmark-OF Smart cleaning tool MPO: N890.120
 - LANmark-OF Smart cleaning tool SC/FC/ST: N890.121
 - LANmark-OF Smart cleaning tool LC/MU: N890.122

Disclaimer

This document is a guideline only. International and local procedures and safety standards must be observed and followed at all times.

Nexans Cabling Systems will not be held liable for any damage or injury to personnel, equipment or business directly or indirectly as a result of using this document in part or in whole.

The practices contained herein are designed as a guide for use by persons having the required technical skill at their own discretion and risk. The recommended practices are based on average conditions. Nexans does not guarantee any favourable results or assume any liability in connection with this document.

Nexans does not assume any responsibility for the accuracy or completeness of this document.

The user should review the information to ensure conformity to the current applicable codes and regulations and to the project requirements.

Nexans reserves the right to change the technical specifications at any time without notice.

Edition 11.08.2015
Copyright © Nexans 2015
All data subject to change
without prior notice.



Nexans Cabling Solutions

Alsebergsesteenweg 2, b3 - B-1501 Buizingen

Tel: +32 (0)2 363 38 00 - Fax: +32 (0)2 365 09 99

Nexans Cabling Solutions UK and Intelligent Enterprise Solutions Competence Centre

2 Faraday Office Park - Faraday Road - Basingstoke - Hampshire RG24 8QQ

Tel: +44 (0)1256 486640 - Fax: +44 (0)1256 486650

www.nexans.com/LANsystems - info.ncs@nexans.com